

Technik

cabinetry system[®]



closet system
installation
manual

got questions?

Call Customer Service at 1-866-285-9104
or email us at:
customer.service@technikclosets.com

thank you for choosing Technik Cabinetry System for your all your needs.

Technik cabinets come fully assembled to make your project an enjoyable and satisfying experience. With quality Technik cabinets, your satisfaction is guaranteed.

If individual shelves and/or closet rods are part of your design and order, you may need to cut them to the proper width. Instructions for how to do that are included.

Before you begin, please read this manual completely so that that you will have a good understanding of the sequence of events.

Please follow all the safety instructions for tools and procedures.

Once again, thank you for choosing Technik.

tools & materials required

Tape measure
Pencil
Level
Stud Finder
Hammer
Screw Driver #2 Flat Head and #2 Phillips
#10 x 3" Pan Head Screws
#8 x 1 1/4" Pan Head Screws

Cordless Drill – to pre-drill cabinets and mount to wall and to each other

3/16", 3/32" Drill bits

Hacksaw – to cut 48" Closet Rods to size if needed

Circular Saw – to cut 48" Furniture shelves to size if needed

wall prep

Note: Attachment to any other surface material such as metal studs, concrete block, brick, stucco or poured concrete require special fasteners. Consult with your local home center, hardware store or installation specialist for recommended fasteners.

INSTALLATION STEPS FOR WALLS WITH WOOD STUDS

1. Before you begin, make sure that your wall is smooth and plumb – remove any obstructions such as old closet organizers, cabinets or baseboards that may interfere with the installation.
2. By using your tape measure and level mark the locations of your base cabinets on the wall - Note the type of closet doors you have and plan accordingly, so that cabinet doors and drawers will open fully without obstruction!
3. Use your stud finder to locate the studs in your wall – mark either side of the stud and the center point, to show where you need to hit with your installation screws. If necessary adjust the location of you cabinets slightly to enable you to hit the required studs easily – adjust all your cabinet location marks.



step 2a



step 3

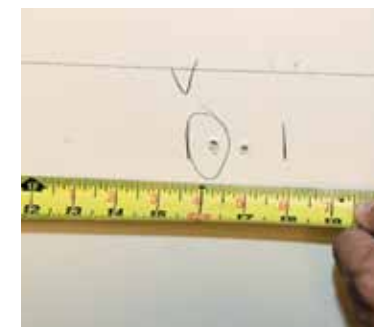

step 3a

42 in. base cabinet installation

4. **Before you start, make installation easier, remove all doors and drawers from the cabinets to be installed. If you've purchased base cabinets with legs, attach them before you start your installation. (See page 7.)**
5. Measure the distance from the outer edge of the first base cabinet to the center of the studs you wish to attach to.

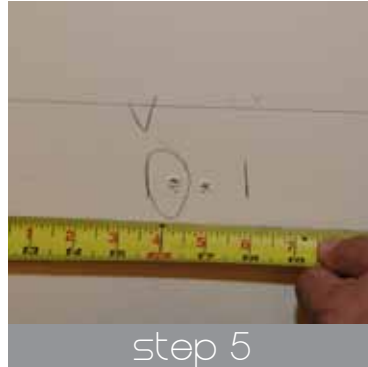

6. Transfer these measurements to the horizontal installation rail, along the back of the base cabinet.
7. Once you place the base cabinet and level, drill pilot holes thru the horizontal installation rail with a 3/32" drill bit.
NOTE: If you can only hit one stud, use a drywall toggle bolt to create a second attachment point (consult your local hardware store for the correct toggle for your wall construction).
**BASE CABINET MUST HAVE TWO ATTACHMENT POINTS!

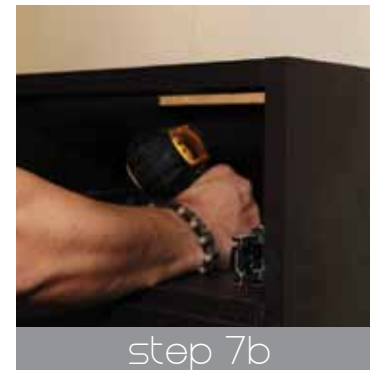

42 in. base cabinet installation continued

8. Attach the base cabinet thru the drywall and into the studs using #10 x 3" pan head screws. Check to see that it's level and shim if it's necessary. (DO NOT FULLY TIGHTEN! Double check for shim and level and adjust if needed).
9. Now drill (2) attachment holes in both the front and back horizontal I-beams using a 3/32" drill bit.



42 in. wall cabinet installation

1. Place the upper cabinet on the lower cabinet and mark the sides and top of the upper wall cabinet on the drywall, remove the wall cabinet.
2. On the wall locate the studs and mark the center of each stud approximately 3" from the top and bottom of the wall cabinet.
3. Transfer these measurements to the two horizontal installation rails, along the back of the wall cabinet at top and bottom.
4. Drill (4) mounting holes thru the installation rails top and bottom of wall cabinet with a 3/32" drill bit.



NOTE: If you can only find one stud, use a drywall toggle bolt to create a second attachment point. (Consult your local hardware store for the correct toggle for your wall construction).

****WALL CABINET MUST HAVE FOUR ATTACHMENT POINTS!**

5. Now place the wall cabinet on top of the base cabinet and align and make sure it's level – hold in place with "Quick Grips" or G-clamps.
6. Attach base cabinet to wall cabinet using #8 x 1¼" pan head screws.
7. Attach the wall cabinet thru the drywall and into the wood studs using #10 x 3" pan head screws or install drywall toggle bolt if necessary - DO NOT FULLY TIGHTEN! Check the level and adjust as needed. Once you are happy with the alignment and level of the two cabinets, fully tighten all the attachment screws.

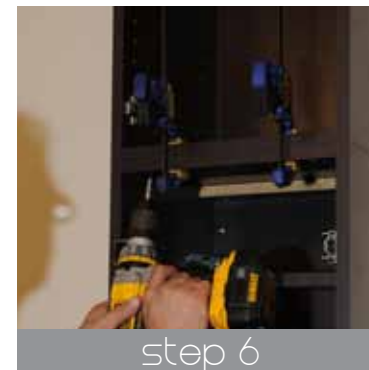

hanging wall cabinet installation

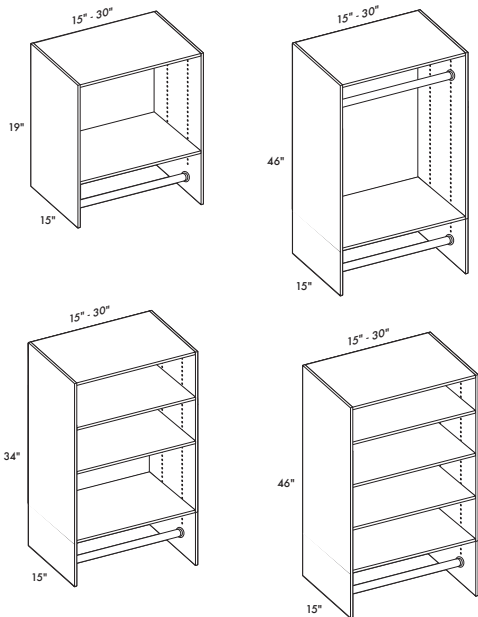

Tall, medium and short Hanging cabinets with rods and the double hanging cabinet with 2 rods are wall cabinets that attach only to the wall and do not have a base cabinet located below them for attachment. These cabinets are hung at the same height as the 42" wall cabinets or 72" wall cabinets in your configuration.

1. Mark a line at the same height as the 42" wall cabinets in your configuration. This will be approximately 84" off the floor. If your configuration involves 72" wall cabinets make your line at the 84" height mark which will be the same for the 72" wall cabinets.
2. On the wall, locate the studs and mark the center of each stud approximately 3" from the top of the line drawn in step 1.
3. Measure the distance from the outer edge of the Hanging wall cabinet to the center of the studs you plan to attach to.
4. Transfer this measurement to the horizontal installation rail along the back of the cabinet.
5. Drill (4) mounting holes thru each installation rail where the studs marks are with a 3/32" drill bit.

NOTE: If you can only hit one stud, use a drywall toggle bolt to create a second attachment point (consult your local hardware store for the correct toggle for your wall construction). **HANGING CABINETS MUST HAVE TWO ATTACHMENT POINTS!**

6. Attach the wall cabinet thru the drywall and into the wood studs using #10 x 3" pan head screws or install drywall toggle bolts if necessary.



72 in. wall cabinet installation

72" Cabinets are intended to attach to and hang from the wall only. The Cabinets have 3 attachment points: top, middle & bottom to ensure a firm attachment. Follow these instructions to mount these larger cabinets to your wall.

1. Before you begin, make sure that your wall is smooth and plumb – remove any obstructions such as old closet organizers or cabinets that may interfere with the installation.
2. By using your tape measure and level mark the locations of your cabinets on the wall – Note the type of closet doors you have and plan accordingly, so that cabinet doors and drawers will open fully without obstruction!
3. Use your stud finder to locate the studs in your wall – mark either side of the stud and the center point, to show where you need to hit with your installation screws. If necessary adjust the location of your cabinets slightly to enable you to hit the required studs easily – adjust all your cabinet location marks.
4. Transfer these measurements to the three horizontal installation rails, along the back of the wall cabinet at top, middle and bottom.
5. Drill (2) mounting holes thru each installation rail where the studs marks are with a 3/32" drill bit.
6. Next attach 1 x 2 furring strips directly below the "wall cabinet bottom level line" to the studs with wood screws (ILLUSTRATION A). These temporary support strips will help to support the weight of the cabinets during installation, and insure that the cabinets are level. You are now ready to begin the cabinetry installation and it is recommended that you remove all doors, drawers and shelves from each cabinet prior to installing to prevent damage.

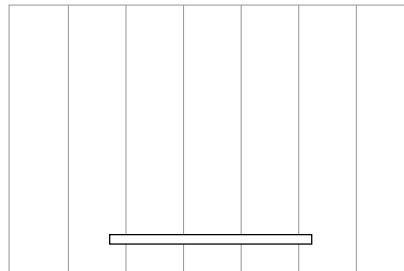
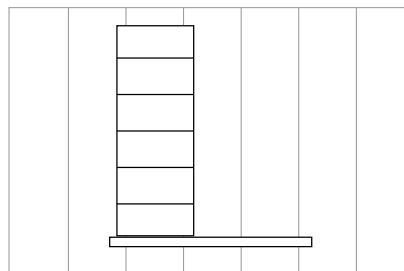

ILLUSTRATION A
Furring Strip

7. Refer to your design layout to determine the location of the first cabinet. Raise cabinet into place resting on the furring strip and fasten the cabinet to the studs with #10 x 2½" pan head screws but do not fully tighten.



72 in. wall cabinet installation

continued

- Determine the next wall cabinet to be installed and repeat the steps above but again do not fully tighten. If this cabinet is adjacent to the first cabinet carefully align the face frames of each cabinet and "C" clamp or "Quick-grip" them together. Gang the cabinets together by drilling pilot holes and uses appropriate screws to secure them together.

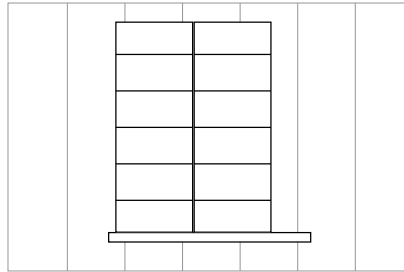

- Once all your cabinets are in place tighten all the screws to lock the cabinets into place. Remove the furring strip which is no longer needed to hold up the cabinets.

shelf corner connector installation

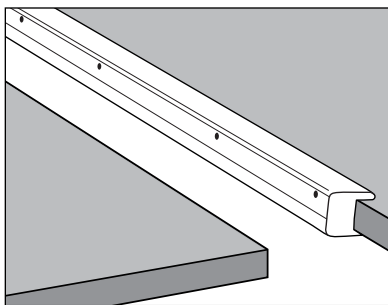

The shelf corner connector allows 2 shelves to be joined together to create a 90° corner condition.

Each corner condition requires a connector, 2 shelves, 2 installation rails to attach to the cabinets and either a 3rd installation rail or closet panel (TCP84) which will be attached to the wall.

Multiple shelf levels will require duplicating the items above each level except if a closet panel is used.

- Install the closet panel or the installation rail to the wall.
- Install installation rails on the cabinet sides at the desired shelf height. Make sure the rail height matches the height of the rail in step 1 or matches the pin hole locations in the closet panel.
- Place the shelf A on the installation rails or pins if closet panel is used.
- Attach the corner connector to the front edge of Shelf A.
- Place the side edge of Shelf B into the corner connector and set other end on the installation rail attached to the cabinet.

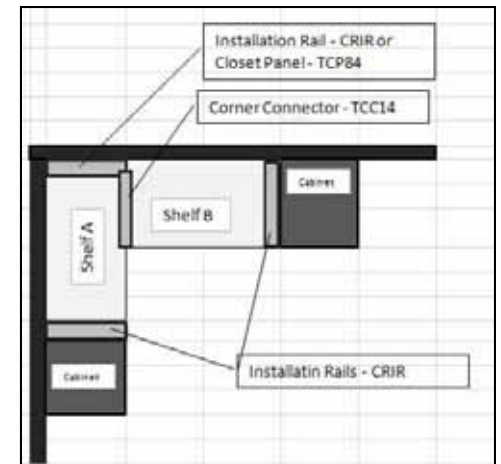

closet rail and rod installation

1. Closet rails can be mounted to the outside of the cabinets, or directly to the drywall of the closet space.
The Closet Rod Installation Rails have two specific purposes:
 - a. They are pre-drilled to accept the Closet Rod Brackets which hold the closet rod in place
 - b. They can also support a $\frac{3}{4}$ " thick shelf above the closet rod
2. Decide on the location of your closet rods and Closet Rod Installation Rails – if you want a $\frac{3}{4}$ " top shelf to align with the top of the wall cabinet, set the Closet Rod Installation Rail $\frac{3}{4}$ " down from the top edge of the wall cabinet (as shown).
3. Use a level to mark a line where the top edge of the Closet Rod Installation Rail will be located.
4. Pre-drill two holes thru the side of the adjacent cabinet to attach the Closet Rod installation Rail.
5. With the pre-drilled holes through the cabinet, attach the Closet Rod Installation Rail using (2) #8 x $1\frac{1}{4}$ " pan head screws.
6. Alternatively, mark the location of the installation rail on the side drywall of the closet space and drill two attachment holes thru the installation rail using $\frac{3}{32}$ " drill bit.
7. Place the installation rail on the drywall and mark the attachment points on the wall.
8. Screw the installation rails in place using a suitable drywall fastener.
9. Once the Closet Rod Installation Rails are installed, you can attach the Closet Rod Brackets.
10. Now measure and cut the closet rod to fit the cups.



steps 3-4



steps 6-8



step 10

two cabinet installation

Determine next base cabinet to be installed and repeat measuring, pre-drilling and installation, but again DO NOT FULLY TIGHTEN. Carefully align the face frames of each cabinet with each other and "G-clip" together. Drill a 3/32" pilot hole in three places along hinge side of frame and secure with #8 x 1 1/4" drywall screws.



cabinet with legs installation



step 1

Lay cabinet on it's side and mount the four adjustable legs to the underside of the cabinet. Position a leg in each corner and make sure the attachment plate overlays the cabinet side panels as shown.



step 2

Before standing cabinet upright, twist adjustment glide to fully extend the glide or extend it to the desired approximate height.



step 3

Complete final adjustments to height of cabinet by turning glide to lower to desired height.

accessories installation



decorative back panel installation

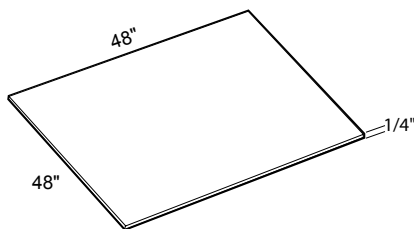

Accessories such as valet rods, tie racks, belt racks and slide-out mirrors can be installed either on the interior side wall of a cabinet or the exterior of the cabinet. Each item has its own installation instruction sheet that comes with the unit. In general:

1. Installation to interior of cabinet
 - a. Each accessory is designed to attach using the pre-drilled holes that have been created in the side walls of the cabinet.
 - b. Each accessory will have 1 or 2 rails (mirror has 2) that attach to the side wall using the screws that come with the accessory.
 - c. For all units, except the mirror, you may choose the height that you wish to install the accessory at.
 - d. The mirror utilizes most of the side of a 42" high cabinet. It can be installed in a 42" hanging cabinet below the hanging bar.
2. Installation on exterior of cabinet
 - a. The placement of an accessory on the exterior of a cabinet is completely up to the user. There are no pre-drilled holes on the exterior.
 - b. Locate the accessory at the desired height.
 - c. Mark the attachment holes based on where the accessory rail(s) are placed.
 - d. Drill pilot holes into the cabinet side.
 - e. Attach the accessory using the screws provided in the accessory kit.

The 48" x 48" decorative panel is designed to provide a finished look for areas behind hanging clothing or areas where shelving is going to be installed but not a cabinet. To install a decorative panel:

1. If needed, cut the panel to the correct size to fit between two cabinets or a cabinet wall.
2. Choose between two methods of attachment:
 - a. Use a caulking adhesive to glue the panel to the wall.
 - b. Use screws to mechanically attach the panel to the wall.

SUGGESTION: Use inside corner molding to decoratively cover up the seam where the panel meets the wall. See Spec Guide for details.

adjusting doors

To insure a perfect spacing and alignment of your doors after installation, Technik Closets hinges are six-way adjustable.

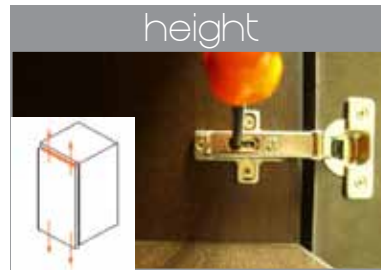

Loosen center screw on each hinge. Move door to desired position. Re-tighten each screw.

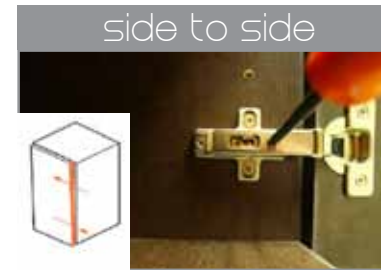

Using a Phillips screw driver, rotate front screw moving the door to desired position.

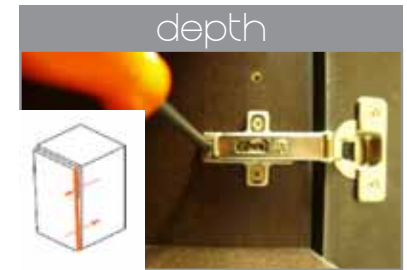

Using a Phillips screw driver, rotate back screw moving the door to desired position.

removing/ adjusting drawers and drawer fronts



step 1
Partially open drawer



step 2
For slide on the left side of drawer box locate the black tab and push UP to release.



step 3
For slide on right side of drawer box locate the black tab and push DOWN to release. With both tabs released at same time slide out the drawer.



step 4
To re-install drawer, simply align the drawer slides on both sides and gently push drawer closed and re-open. Locking tabs do not need to be pressed.



step 5
Open and close drawer several times to align the slides.



NOTE: ADJUST DRAWER FRONT BEFORE INSTALLING DECORATIVE HARDWARE!

drawer front adjustment
If additional adjustment is required, loosen screws and twist drawer front for proper alignment. Tighten screws securely.

attaching decorative hardware

The decoration hardware you select may vary in size. Do not drill holes until you have determined the dimensions match the decorative hardware you have selected. Make sure that you or your contractor adjust the alignment of all doors and drawer fronts prior to drilling them for pulls or knobs - once the decorative hardware is installed it will be difficult to adjust the doors and drawer fronts.

1. Clamp a piece of wood to the front side of the door or drawer front, at handle location.
2. From the inside of the door use a 3/16" drill bit and be sure to drill completely through the door or drawer front into the block this allow for a clear hole. Push the bolt through the hole and apply the hardware. Tighten from the inside of the door or the drawer with a screwdriver.

We hope your Technik Cabinetry System project has been a pleasant and rewarding experience.